

**K.V. NO. 1 SHAHIBAUG AHMEDABAD**

**WORKSHEET**

**CLASS - 2**

**SUBJECT - ENGLISH(unit 8)**

**NAME:** \_\_\_\_\_

**CLASS & SEC** \_\_\_\_\_

**DATE:** \_\_\_\_\_

**GRADE**   ★  ★  

**Q1.** Write the names of following musical instruments-

Table

Guitar

Harmonium

Dholak

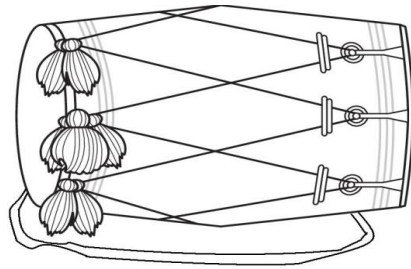

\_\_\_\_\_

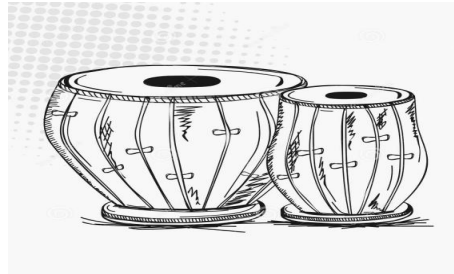

\_\_\_\_\_

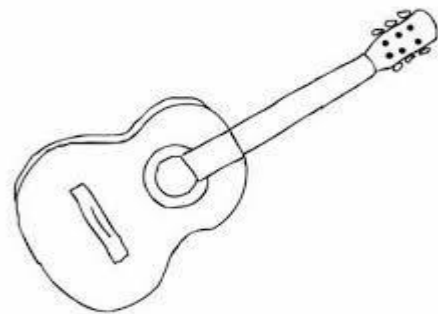

\_\_\_\_\_

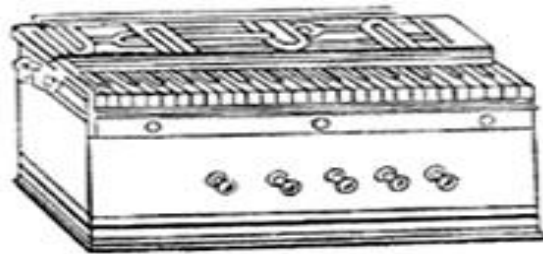

\_\_\_\_\_

**Q2.** Join the two words:

1) Time + table    Timetable

2) News + paper    \_\_\_\_\_

3) Foot + ball    \_\_\_\_\_

4) Car + pet    \_\_\_\_\_

5) Tooth + paste    \_\_\_\_\_

6) Music + man    \_\_\_\_\_

**Q-3 Write the rhyming words.**

**Man** .....

**Play** .....

**Song** .....

**Tall** .....

**Far** .....

**Q-4: Make 3 sentences using the words from each columns:**

<b>Column A</b>	<b>Column B</b>	<b>Column C</b>
Baker	treats	thief
Doctor	drives	patient
Driver	catch	cake
Policeman	bakes	vehicle

A. Baker bakes cake.

B. \_\_\_\_\_

C. \_\_\_\_\_

D. \_\_\_\_\_

**Q-5 Answer the following Questions:**

1. What can a music man play?

Ans: \_\_\_\_\_

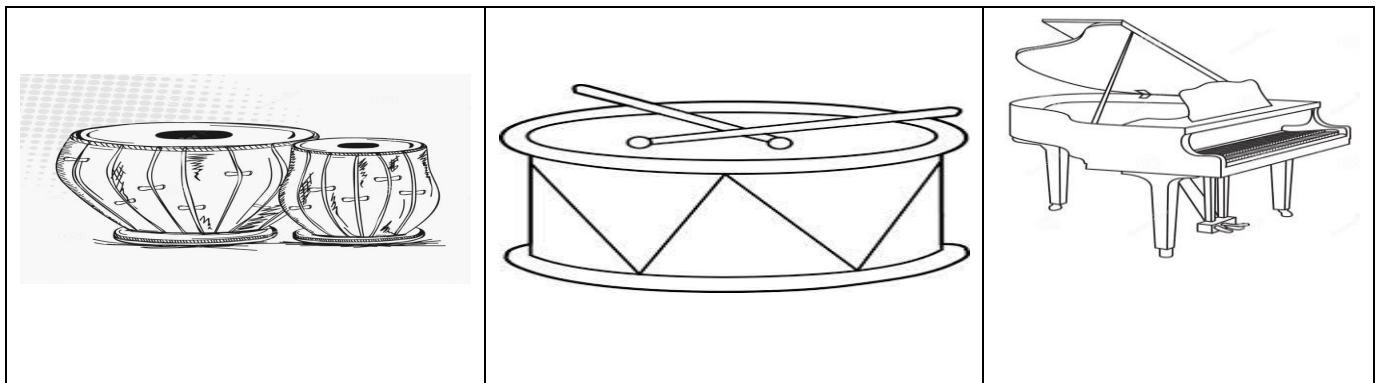

**K.V. NO. 1 SHAHIBAUG AHMEDABAD**

**WORKSHEET**

**CLASS - 2**

**SUBJECT - ENGLISH(unit 8)**

**NAME: \_\_\_\_\_**

**CLASS & SEC \_\_\_\_\_**

**DATE: \_\_\_\_\_**

**GRADE  \_\_\_\_\_**

**Q-1 Fill in the blanks with vowels ( a,e,i,o,u)**



**T \_ B L \_**



**G \_ I T \_ R**

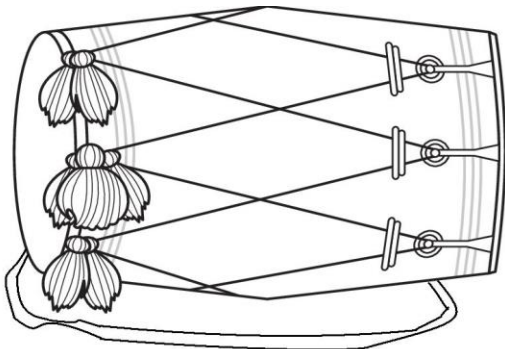

**D H \_ L \_ K**

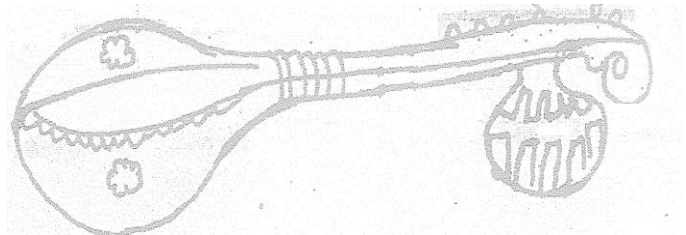

**S \_ T \_ R**

**Q2 Match the rhyming word**

**Can**

**Play**

**Far**

**Song**

**Cat**

**Long**

**Fat**

**Car**

**Man**

**Clay**

**Q3- Join the correct pair .**

**Tooth**



**Music**



**News**



**Foot**



**Car**



**K.V. NO. 1 SHAHIBAUG AHMEDABAD**

**WORKSHEET**

**CLASS - 2**

**SUBJECT - ENGLISH(unit 8)**

**NAME:** \_\_\_\_\_

**CLASS & SEC** \_\_\_\_\_

**DATE:** \_\_\_\_\_

**GRADE** ☆ ☆ ☆

**Q1.** Write names of following musical instruments-

(1) \_\_\_\_\_

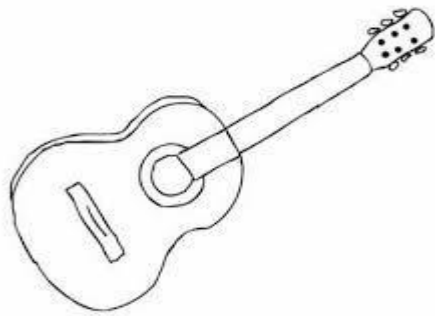

(2) \_\_\_\_\_

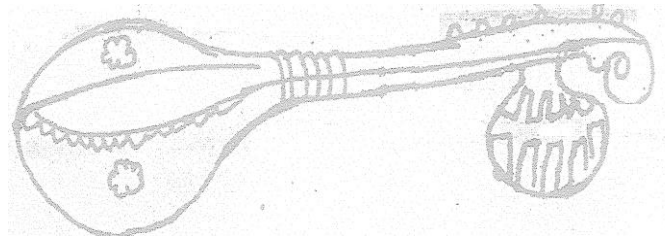

(3) \_\_\_\_\_

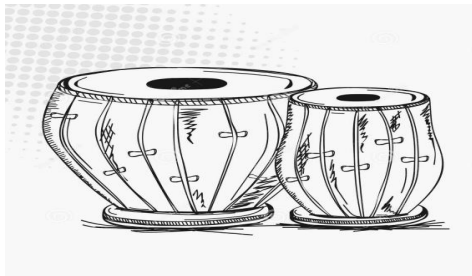

(4) \_\_\_\_\_

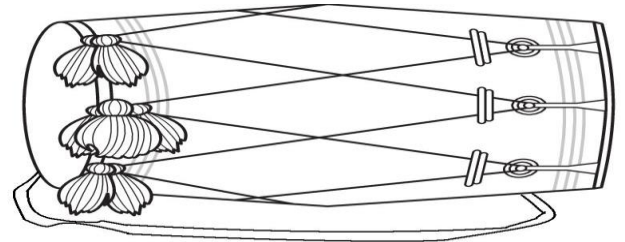

(5) \_\_\_\_\_

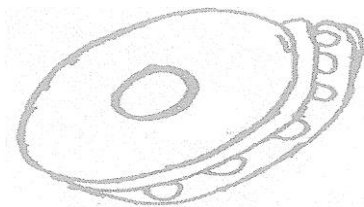

(6) \_\_\_\_\_

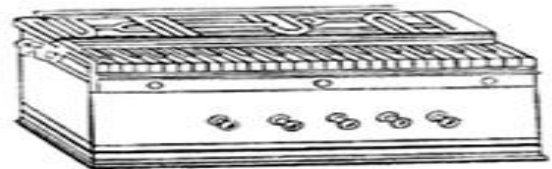

(7) \_\_\_\_\_

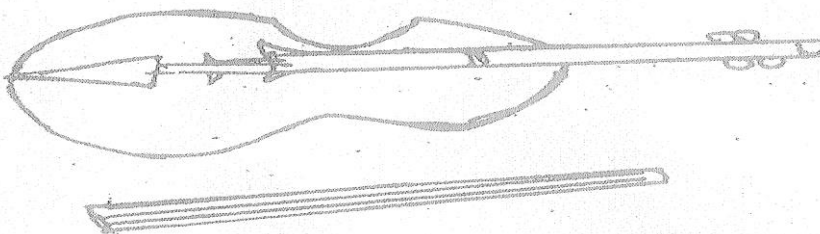

**Q2. Join the two words:**

**Time + table** \_\_\_\_\_

**News + paper** \_\_\_\_\_

**Foot + ball** \_\_\_\_\_

**Car + pet** \_\_\_\_\_

**Tooth + paste** \_\_\_\_\_

**Q3. Write names of these musical instruments into three groups based on how they are played –**

<b>TABLE</b>	<b>SITAR</b>	<b>FLUTE</b>	<b>IKTARA</b>
<b>GUITAR</b>	<b>DHOLAK</b>	<b>VIOLIN</b>	<b>DAFLI</b>
<b>SHEHNAI</b>			

<b><u>INSTRUMENTS PLAYED BY FINGERES-</u></b>	<b><u>STRING INSTRUMENTS</u></b>	<b><u>INSTRUMENTS YOU BLOW INTO-</u></b>

**Q 4: Answer the question:**

**1.What can a music man play?**

**Ans:** \_\_\_\_\_

—

**2.Who were Goopu's friends?**

**Ans:** \_\_\_\_\_